

## Golf Banner Silves

Outdoor Fabric A-frame. The system allows a rapid single person set-up. Components:

- Black round bag.
- Hooks.
- Fiber glass pole conector.
- Fiber glass pole.
- Plastic connectors.
- Black margin 60mm width.

**Material:** Fiberglass, plastic parts.

	QTY	N.W(kg)	G.W(kg)	C.B.M.	Size(mm)
<b>Packing</b>	5	12.50	13	0.26	1200x180x1200
<b>Uni.</b>	1	2.50	2.60	0.05	1140x1140x30

**10.426**      **1100x2700mm**

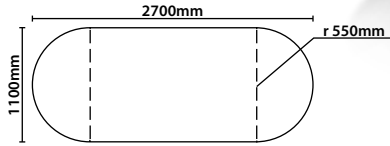
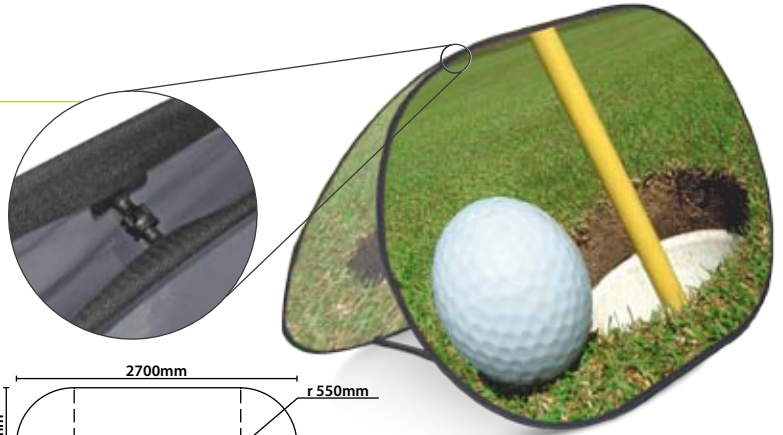

	QTY	N.W(kg)	G.W(kg)	C.B.M.	Size(mm)
<b>Packing</b>	5	8.50	30	0.16	950x950x180
<b>Uni.</b>	1	0.90	1	0.045	950x950x50

**10.427**      **1000x2000mm**

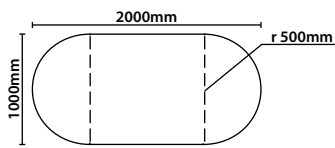

	QTY	N.W(kg)	G.W(kg)	C.B.M.	Size(mm)
<b>Packing</b>	5	7	7.25	0.08	660x180x660
<b>Uni.</b>	1	1.40	1.45	0.012	640x640x30

**10.428**      **620x1260mm**

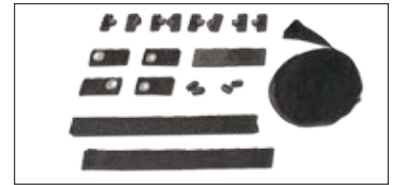
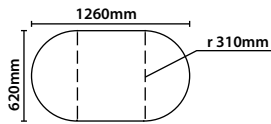

## Golf Banner Cardiff



Outdoor fabric A-frame.

**Material:** Fiberglass.

	QTY	N.W (kg)	G.W (kg)	C.B.M.	Size(mm)
<b>Packing</b>	1	0.52	1.59	0.15	730x300x730

**10.653**      **Ø 700mm**



## Golf Banner Tychy



Outdoor fabric.

**Material:** Fiberglass.

	QTY	N.W (kg)	G.W (kg)	C.B.M.	Size(mm)
<b>Packing</b>	1	1	2.07	0.15	730x300x730

**10.654**      **2500x750mm**



# BARRIER BANNER - OUTDOOR BANNER

1

## Barrier Banner



Consists of aluminium frame, loops, hooks for fixing the digitally printed banner and tent pegs for fixing the frame in soft ground. No tools required for assembly. For indoor and short-term outdoor use. Price includes bag. Size: 2470x955mm.

**Material:** Aluminium.

	QTY	N.W(kg)	G.W(kg)	C.B.M.	Size(mm)
Uni.	1	7	8.1	0.049	200x200x1220

10.548

2410x900mm



## Outdoor Banner Charleroi



1200mm

4 kgs Water

Stable, heavy and durable pavement sign. Suitable to set aside on play grounds, shop entrances and pavement roads. Double face. Water or sand base.

**Material:** Plastic.

	QTY	N.W (kg)	G.W (kg)	C.B.M.	Size(mm)
Packing	1	2	2.5	0.07	500x200x690

10.248

382x330mm



## Outdoor Banner Delta



Double side plastic stand. Outdoor - Indoor use.

**Material:** Plastic.

	QTY	N.W (kg)	G.W (kg)	C.B.M.	Size(mm)
Packing	1	7	8	0.05	1010x630x80

10.679

550x700mm



# OUTDOOR BANNER

## Almazan



X-Banner with large plastic base that can be filled with water.

**Material:** Fiberglass, aluminium.

	QTY	N.W (kg)	G.W (kg)	C.B.M.	Size(mm)
Pole	1	0.55	0.6	0.004	750x80x65
Base	1	0.95	1	0.015	170x250x350

**10.028**      **600X1800mm**



## Outdoor Roll Up Haro



Exterior double side banner with plastic base that can be filled with water.

**Material:** Aluminium, plastic.

	QTY	N.W (kg)	G.W (kg)	C.B.M.	Size(mm)
Packing	1	17.7	19.6	0.17	1160x230x620

**10.954**      **800x2000mm**



## Almenar



Y-Banner with plastic base that can be filled with water. Adjustable height.

**Material:** Fiberglass, aluminium.

	QTY	N.W (kg)	G.W (kg)	C.B.M.	Size(mm)
Packing	6	13	16.20	0.1	850x400x320
Uni.	1	1.8	2.2	0.02	840x240x100

**10.029**      **800X1900mm**



## Lillo



Double sided banner, plastic base that can be filled with water.

**Material:** Aluminium, plastic parts.

	QTY	N.W (kg)	G.W (kg)	C.B.M.	Size(mm)
Packing	1	14.2	25	0.12	920x670x200

**10.768**      **850x2500mm**



35 kgs Water

# OUTDOOR BANNER

1

## Medinaceli



Banner with plastic base that can be filled with water.

**Material:** Steel, plastic parts.

	QTY	N.W (kg)	G.W (kg)	C.B.M.	Size(mm)
Packing	2	7	8.6	0.11	190x540x1050
Uni.	1	2.85	3.50	0.05	1030x500x100



10.026

450x1600mm



## Cepeda



Exterior banner with plastic base that can be filled with water. Adjustable in height.

**Material:** Steel, plastic parts.

	QTY	N.W (kg)	G.W (kg)	C.B.M.	Size(mm)
Pole	1	1.5	1.7	0.01	1160x100x90
Base	1	2	2.25	0.05	460x470x240

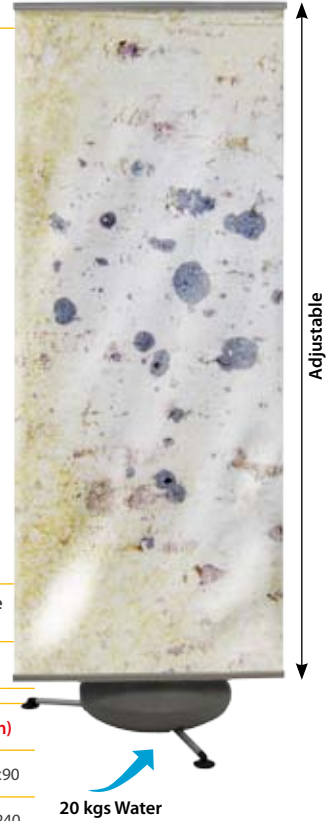

10.800

800x1800-2300



## Kiel



Double sided



Single or double sided water filled Banner. Telescopic aluminium support pole and adjustable central hub allows for adjustment of height. Graphic area recommended: 900x1750mm.

**Material:** Aluminium, plastic parts.

	QTY	N.W(kg)	G.W(kg)	C.B.M.	Size(mm)
Uni.	1	2.8	3.25	0.09	1080x400x200

10.573

900x1750mm



	QTY	N.W(kg)	G.W(kg)	C.B.M.	Size(mm)
Uni.	1	3	3.45	0.09	1080x400x200

10.574

900x1750mm



# OUTDOOR BANNER

## Yuste

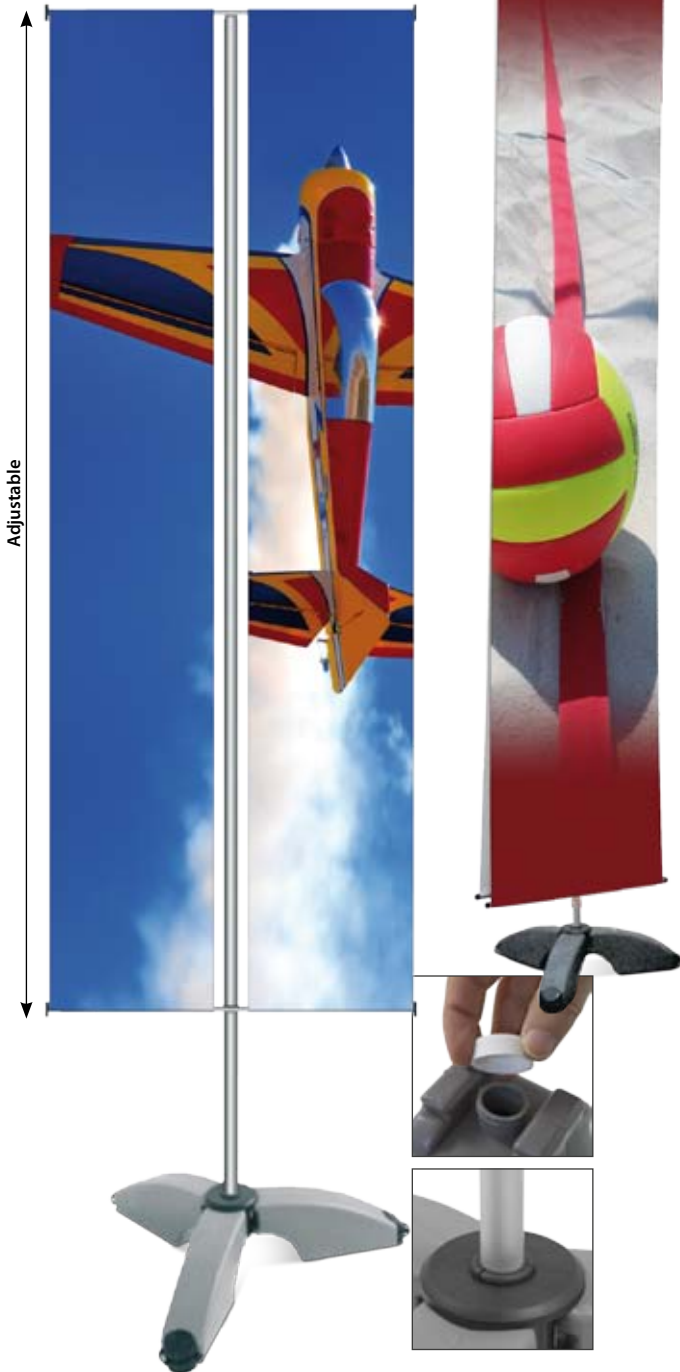

Outdoor flagpole. Can be used with two graphic. Water filled stand.

**Material:** Aluminium, plastic parts.

	QTY	N.W(kg)	G.W(kg)	C.B.M.	Size(mm)
<b>Pole</b>	1	1.35	1.85	0.015	1650x120x80
<b>Base</b>	1	0.95	1.15	0.017	200x340x260

**10.709**      **600x1500-4500**



## Bierzo



Outdoor flagpole. Water filled stand. Adjustable size. Maximum graphic size: 700x2500mm.

**Material:** Steel, plastic parts.

	QTY	N.W (kg)	G.W (kg)	C.B.M.	Size(mm)
<b>Pole</b>	1	0.7	0.7	0.001	1610x25x25
<b>Base</b>	1	1.05	1.45	0.027	350x350x220

**10.027**      **300x2000mm x2**



## Magaz

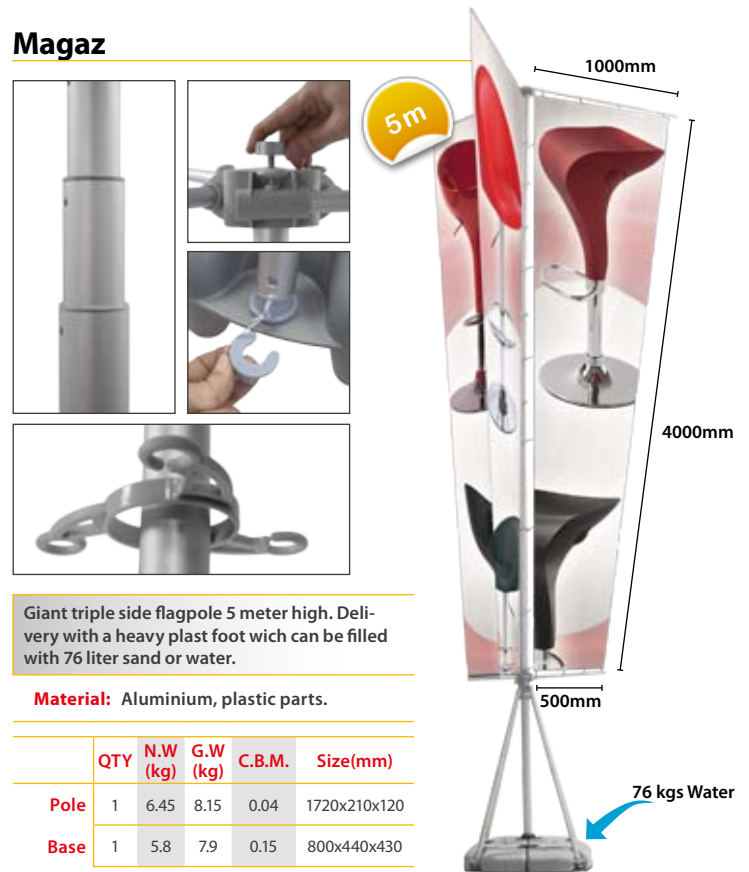

Giant triple side flagpole 5 meter high. Delivery with a heavy plast foot wich can be filled with 76 liter sand or water.

**Material:** Aluminium, plastic parts.

	QTY	N.W (kg)	G.W (kg)	C.B.M.	Size(mm)
<b>Pole</b>	1	6.45	8.15	0.04	1720x210x120
<b>Base</b>	1	5.8	7.9	0.15	800x440x430

**10.740**      **1000/500x4000mm x3**



# OUTDOOR BANNER

1

## Brest



50 kgs Water



Giant flagpole 4,1 meters high. Delivery with a heavy plast foot wich can be filled with 50kg. sand or water.

**Material:** Aluminium, plastic parts.

	QTY	N.W(kg)	G.W(kg)	C.B.M.	Size(mm)
<b>Pole</b>	4	5.5	22	0.137	1630x295x295
<b>Base</b>	1	6	6.3	0.088	665x265x665

10.652

800x2800mm



## Cergy



10.577

76 kgs Water

10.578

134 kgs Water

Giant flagpole 7 or 9 meters high. Delivery with a heavy plast foot wich can be filled with sand or water.

Ref.: 10.577 graphic size: ± 1200x6000mm.

Ref.: 10.578 graphic size: ± 1200x7500mm.

**Material:** Aluminium, plastic parts.

	QTY	N.W (kg)	G.W (kg)	C.B.M.	Size(mm)
<b>Pole</b>	1	6.5	7.5	0.03	1710x150x130
<b>Base</b>	1	8	9	0.13	805x410x410

10.577

1200x6000mm



	QTY	N.W (kg)	G.W (kg)	C.B.M.	Size(mm)
<b>Pole</b>	1	8.5	9.5	0.05	1710x180x170
<b>Base</b>	1	14	15	0.24	920x510x510

10.578

1200x7500mm



## Bejar

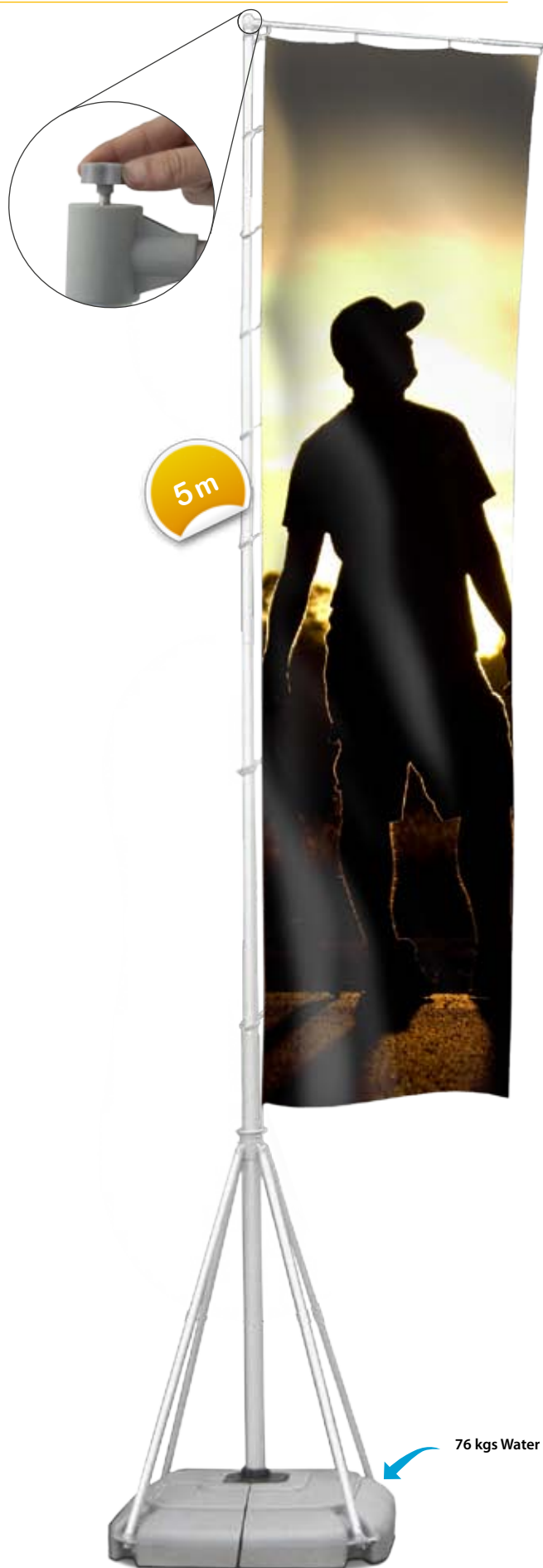

Giant Flagpole 5 meter high. Delivery wity a heavy plast foot wich can be filled with 76 liter sand or water. 10828: includes plastics clips for bottom graphics.  
Graphic size: 1100x3500mm.

**Material:** Aluminium, plastic parts.

	QTY	N.W(kg)	G.W(kg)	C.B.M.	Size(mm)
Pole	1	7.5	9.8	0.04	130x160x1680
Base	1	10	11	0.14	380x430x850

10.031 1100x3500mm



# OUTDOOR BANNER

1

## Molar

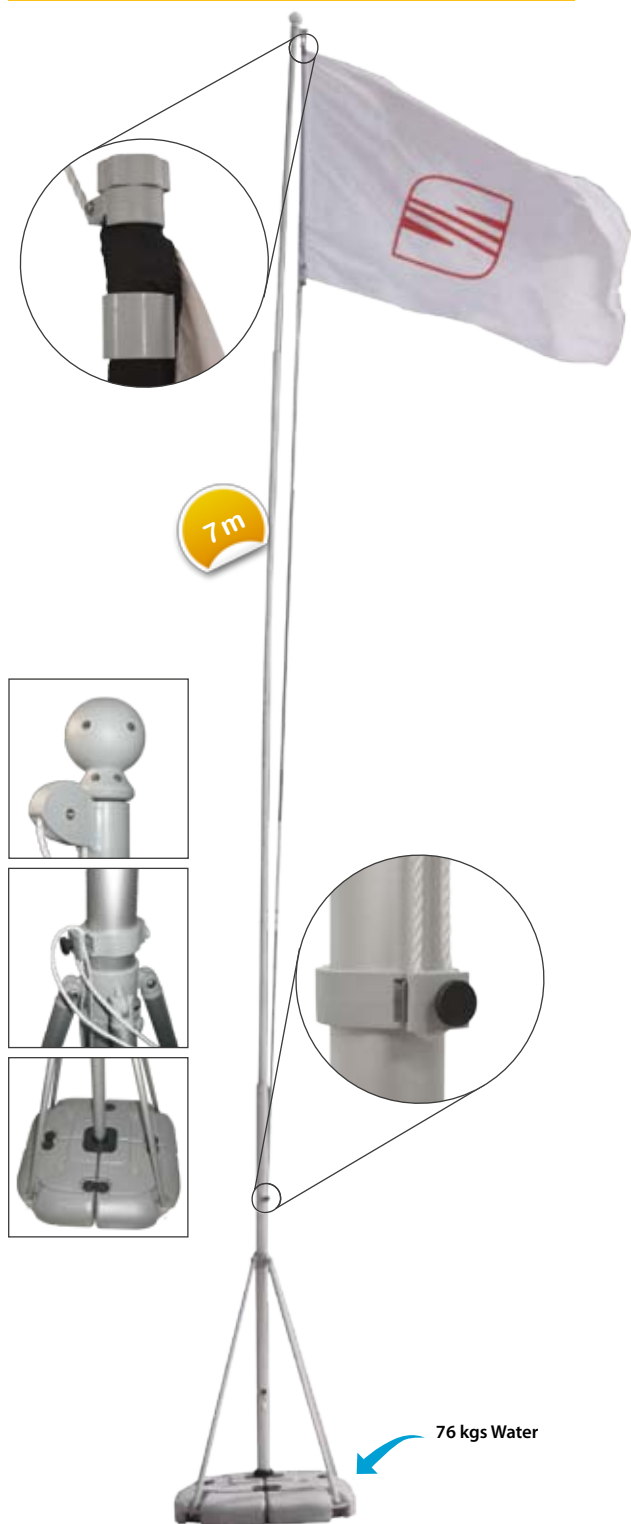

Giant flagpole 7 meter high. Delivery with a heavy plast foot wich can be filled with 76 liter sand o water. Graphic size: adjustable.

**Material:** Aluminium, plastic parts.

	QTY	N.W(kg)	G.W(kg)	C.B.M.	Size(mm)
Pole	1	5	6.5	0.055	210x120x2170
Base	1	10	12	0.15	860x420x410

10.743

7000mm



## Lamp System

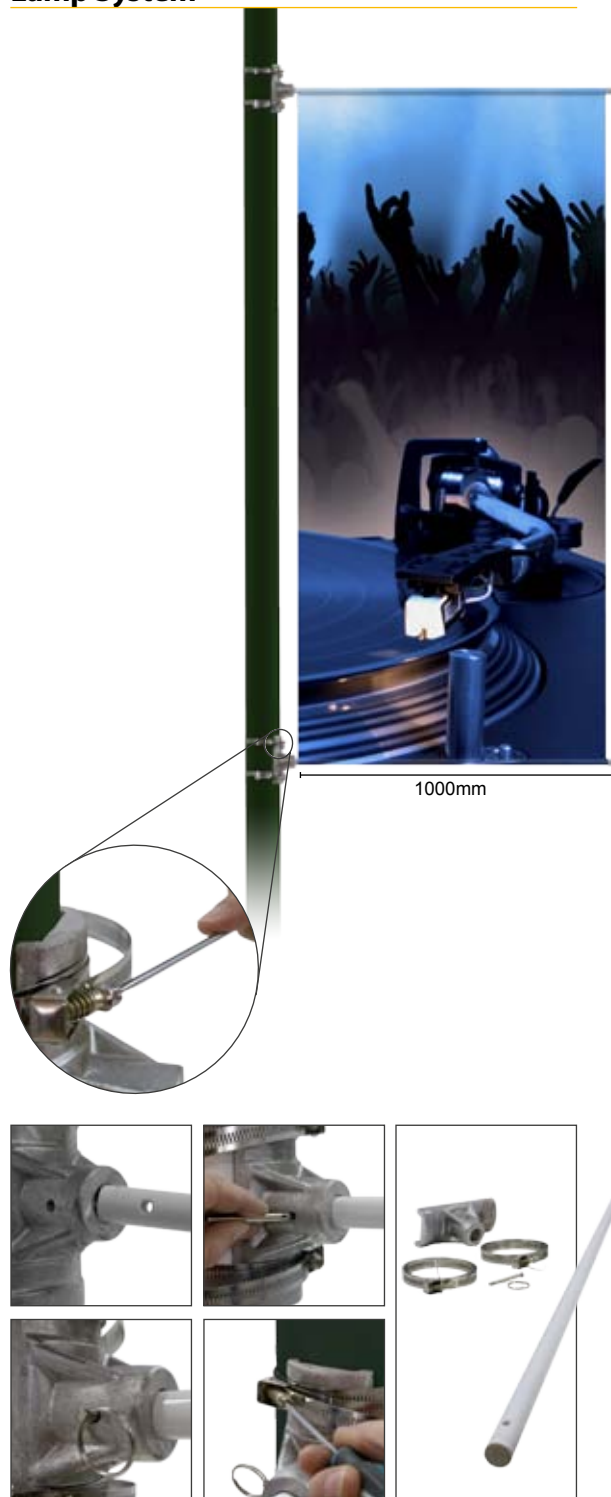

Banner flag system for lamp or another outdoor post. This support is designed for stronger wind conditions. Each kit includes:

- 1 aluminium bracket.
- 1 pin and 1 ring.
- 2 stainless steel band.
- 1 fiberglass pole 1000mm. length.

**Material:** Aluminium, plastic parts.

	QTY	N.W(kg)	G.W(kg)	C.B.M.	Size(mm)
Uni.	1	1	1.35	0.006	1010x100x65

12.353

# OUTDOOR BANNER

## Barahona - 1



A-Banner outdoor stand systems with water/sand fillable base offering impressive single or double sided graphic displays. Graphic size: 2500x2000mm.

**Material:** Aluminium, plastic parts.

	QTY	N.W(kg)	G.W(kg)	C.B.M.	Size(mm)
Pole	1	11.5	16	0.04	1660x210x410
Base	1	8	9	0.11	850x310x430

**10.030 3000x2000/2500mm**



## Barahona - 2

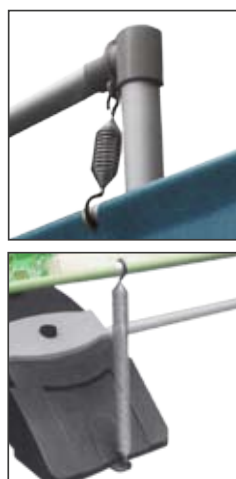

Double sided

25 kgs Water



A-Banner giant outdoor stand systems with water/sand fillable base offering impressive single or double sided graphic displays.

**Material:** Aluminium, plastic parts.

	QTY	N.W(kg)	G.W(kg)	C.B.M.	Size(mm)
Pole	1	17.2	21.1	0.044	1720x150x170
Base	1	13.30	18.3	0.12	850x300x470

**10.830 5640x2450mm**

